

Türarm zentrisch

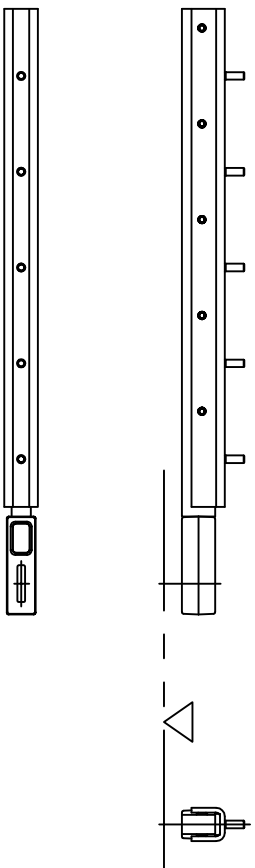

Türarm zentrisch, Pankeinrichtung

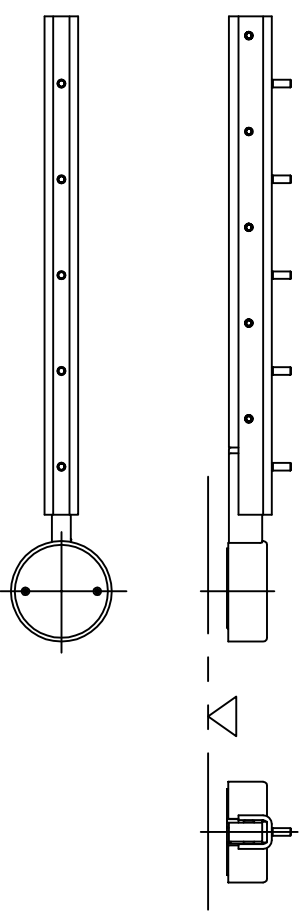

Türarm exzentrisch, Typ L

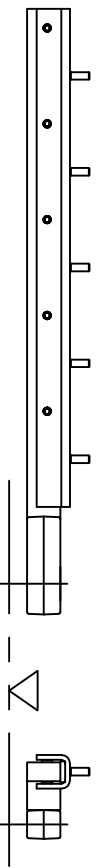

Türarm exzentrisch, Typ R

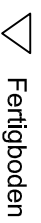
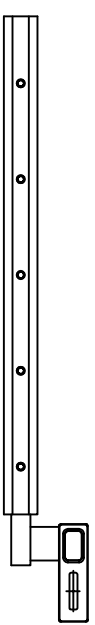
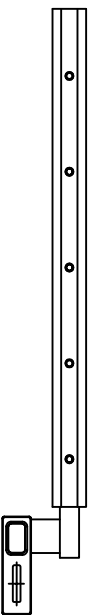
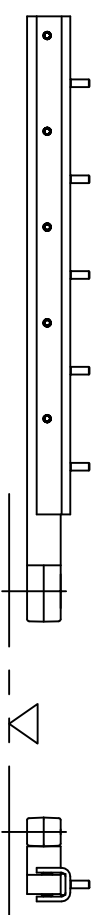

Fertigboden

Objekt:			
Kunde:			
AuftragsNr.:		Datum:	
Freigabevisum:			
Antriebstyp : <b>Power Drive 1401 Türarm</b>		Massstab	Gezeichnet
Ausführung:		%	Gut zum Druck
<b>Power Drive 1401 Türarm</b>			<b>20.02.07 RAST</b>
 <small>TORMAX ist eine Division und ein registriertes Markenzeichen der Landet Motoren AG, CH-9180 Bülach-Zürich</small>		DokumentNr.:	Index
		<b>T4_386_52</b>	.